

EDGESolo325 Surface

3.25" Edge-Lit Linear LED Surface Mount

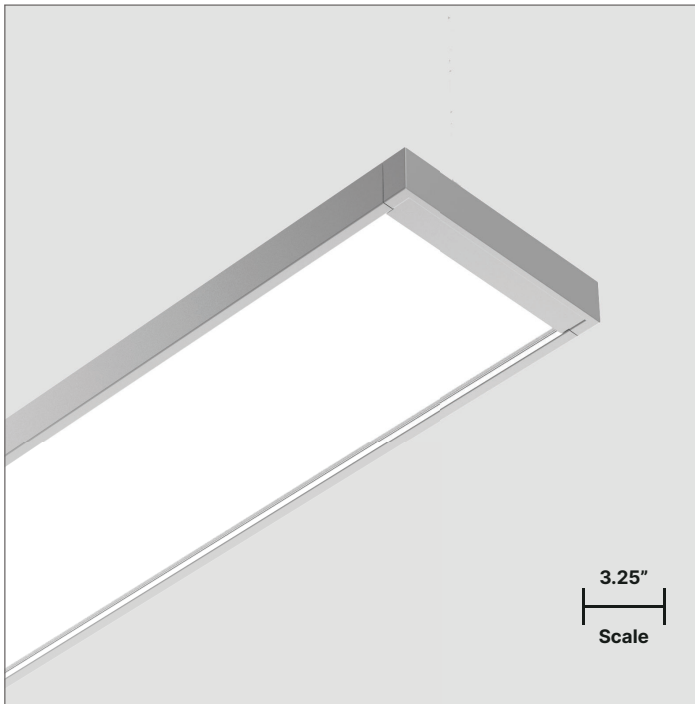

Features & Benefits

Exceptional Performance

Up to 1,500 lm/ft, 135 lm/W efficacy

Wide Range of LED Selections

Static and Tunable White

Designed with Options

Wide choice of SmartOptic® lenses, beam distributions, 80/90/95+ CRI, 2200K to 5000K CCT, and 0-10V, DALI, DMX, and TRIAC dimming

Patented Innovations

Fusion® Optix Inside with unique SmartBeam® capabilities

Proprietary Optical Components

Provides excellent light distribution and high-transmission

Committed to Sustainability

Declare Listed and Red Free List materials

Compliance

UL Listed, Dry and Damp Locations

5-Year Warranty

Standard 5-year warranty, 50,000 hours



Designed & Built in
BOSTON

Declare



FIXTURE ORDERING

Project Name

1) FIXTURE DESIGN

Fixture Type

PRODUCT	MOUNTING TYPE		LENGTH		FINISH		END CAP	
ES0325-S								
3.25" Edge-Lit Linear LED Surface Mount	DW	Drywall	2FT	2ft nominal	MWH	Matte White (RAL9003)	EC1	Flat End Cap
	DWJ	Drywal J-Box Mount	4FT	4ft nominal	MBK	Matte Black (RAL9005)	EC2	Chamfered End Cap
	M1	Magnet Mount	6FT	6ft nominal	MGR	Matte Gray (RAL7001)		
	T1	9/16" Flat T-Bar	8FT	8ft nominal	CAE	Clear Anodized Effect		
	T2	9/16" Bolt Slot T-Bar	10FT	10ft nominal	RAL_	Specify RAL#		
	T3	15/16" Flat T-Bar	X_	Specify X', Y"				
	X_	Specify						

2) LED LIGHT ENGINE

OPTIC	CRI	CCT	DIRECT BEAM PATTERN		DIRECT OUTPUT				
ORL	Regressed Lens	S80	Std. 80 CRI	22	2200K	DLAM	Lambertian	35	350 lm/ft
OFL	Flush Lens	S90	Std. 90 CRI	27	2700K	DBW65	Batwing 65°	50	500 lm/ft
ORLBB	Regressed Lens + Black Baffle	HE80	High-Eff. 80 CRI	30	3000K	DA5025	Asymmetric 50° at 25° Tilt	75	750 lm/ft
		HE90	High-Eff. 90 CRI	35	3500K	X_	Specify Beam	100	1,000 lm/ft
ORLSHB	Regressed Lens + Silver Hex Baffle	HD95	High-Def. 95 CRI	40	4000K			125	1,250 lm/ft
		SUN	Full SunLike	50	5000K			150	1,500 lm/ft
		X_	Specify CCT	X_				X_	Specify lm/ft

3) FIXTURE POWER & CONTROLS

LINE VOLTAGE (DC)	REMOTE DRIVER (POWER)	REMOTE DRIVER BOX ¹	EMERGENCY BACKUP	CONTROL SYSTEM ³
UNV 120/277V	FDND Factory Non-Dimming	NN Not Needed	NN Not Needed	NN Not Needed
347 347V	FD01 Factory 0-10V 1% Dim	RLDB² Remote Linear Driver Box (driver included by default)	EMC Emergency Circuit	LUT Lutron
	FD10 Factory 0-10V 10% Dim	RX2D² Optional Remote XBox2 Driver, Up to 2 Drivers	EMB Emergency Battery (10 W — Remote)	COO Cooper
	FDDA Factory DALI 0.1% Dim	RX3D² Optional Remote XBox3 Driver, Up to 3 Drivers	X_ Specify Backup	CAS Casambi
	FDDX Factory DMX Dim	RX5D² Optional Remote XBox5 Driver, Up to 5 Drivers		X_ Specify Control System
	FDTR Factory TRIAC Dim			
	LD01 Lutron Hi-Lume 1% Dim			
	LD05 Lutron 5-Series 5% Dim			
	ED00 eldoLED 0-10V 0.1% Dim			
	ED01 eldoLED 0-10V 1% Dim			
	EDDA eldoLED DALI 0.1% Dim			
	X_ Specify Driver			

4) OTHER ITEMS

POWER CORD	MOUNTING ACCESSORIES
<input type="text"/>	<input type="text"/>

PC24WH 24" White Power Cord
PC24BL 24" Black Power Cord

SSMB Stainless Steel Surface Mounting Bracket

Footnotes: ¹ Remote distance is dependent on driver type, up to 100' (30.5 m). ² Creates a clean and organized power solution for multiple fixture installations.
³ The control system and driver must be compatible.

FIXTURE DESIGN

Dimensions

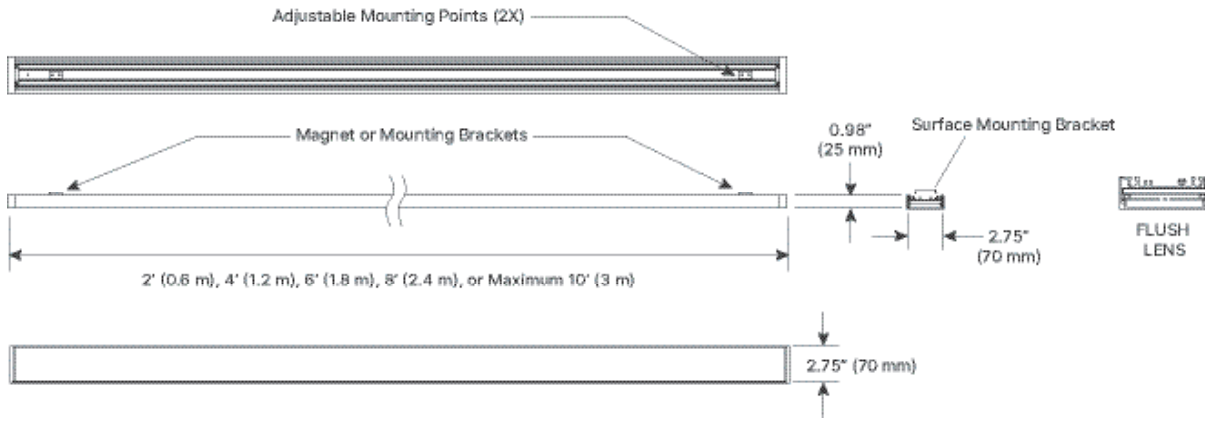

To download BIM (Revit) Files, please click or scan the QR Code.

Length

Length Options 2', 4', 6', 8', 10' nominal, or custom within 3"

Finish

Housing Colors (Matte Finish)



White (RAL9003)



Black (RAL9005)



Gray (RAL7001)



Clear Anodized Effect



Custom RAL

Housing Material 6063-T5 extruded, recycled aluminum

Mounting Brackets Sheet metal

End Cap

End Cap Option Chamfered

End Cap Material Machined or cast aluminum

Optic

Lens Option Flush

Lens Material Patented SmartOptics® made from Acrylic (PMMA)

Voltage

Fixture Voltage (AC) 120–277 VAC and 347 VAC, 50/60 Hz

OPTIC	BEAM PATTERN		
	DLAM	DBW65	DA5025
Flush Lens	●	●	●

DIRECT PHOTOMETRICS

Static White Light

DLAM: Lambertian

DBW65: Batwing 65°

DA5025: Asymmetric 50° at 25° Tilt

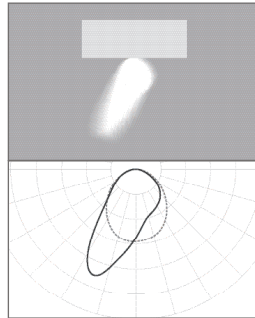
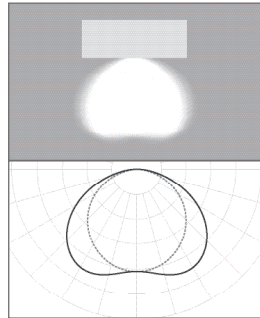
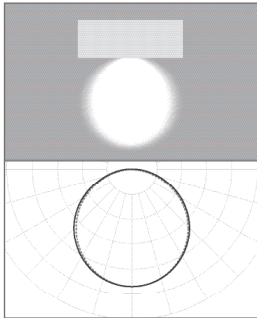

Length 48"
LED HE80
CRI/CCT 80+/3500K
Lumens 3,000
lm/ft 746
Watts 27
W/ft 6.8
LPW 110

Length 48"
LED HE80
CRI/CCT 80+/3500K
Lumens 3,000
lm/ft 743
Watts 27
W/ft 6.8
LPW 109

Length 48"
LED HE80
CRI/CCT 80+/3500K
Lumens 3,000
lm/ft 738
Watts 10.5
W/ft 5.3
LPW 141

LED SELECTION GUIDE

S80: Standard 80+ CRI

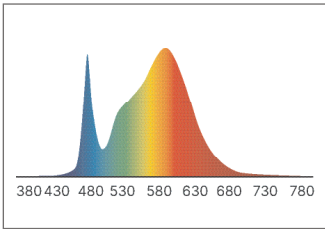

S90: Standard 90+ CRI

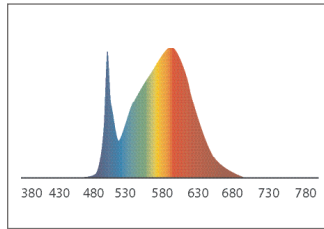

HE80: High-Efficiency 80+ CRI

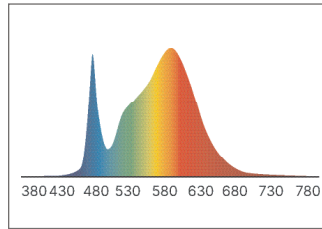

HE90: High-Efficiency 90+ CRI

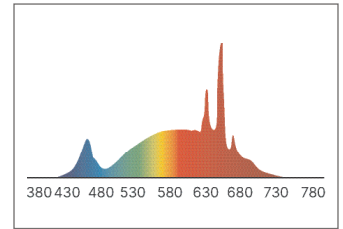

HD95: High-Definition 95+ CRI

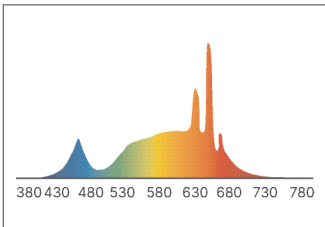

SUN: Full Spectrum "SunLike"

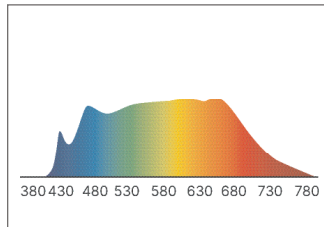

HCD: Human Centric Day

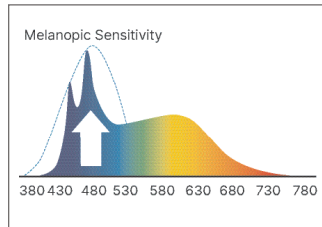

HCN: Human Centric Night

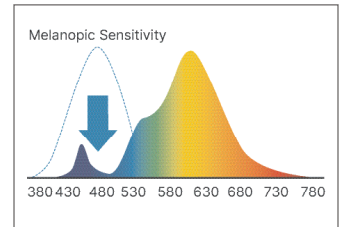

Static White Light (LED Light Engine Only)

CODE	DESCRIPTION	TYPICAL LED DATA							
		CCT	CRI	CRI R9	TM30 Rf	TM30 Rg	CQS	M/P Ratio	LPW
S80	Standard 80 CRI	3500K	82.5	7.8	84	96.7	82.5	0.51	190
S90	Standard 90 CRI	3500K	91	54.3	89.3	98.9	89.2	0.55	175
HE80	High Efficiency 80 CRI	3500K	82.1	5.9	83	94.2	81.2	0.52	210
HE90	High Efficiency 90 CRI	3500K	92.2	90	90.7	103.8	92.1	0.56	190
HD95	High Definition 95 CRI	3500K	97.1	95	-	-	-	0.70	163
SUN	Full Spectrum SunLike®	3500K	95	85	-	-	-	-	130
HCD	Human Centric Day	4000K	83	95	-	-	-	0.92	155
HCN	Human Centric Night	2700K	80	-	-	-	-	0.44	134

LPW Efficacy Conversion Chart

CODE	CCT SELECTED							
	2200K	2700K	3000K	3500K	4000K	5000K	5700K	6500K
S80	-	0.91	0.96	1.00	1.04	1.11	1.11	1.11
S90	-	0.91	0.96	1.00	1.04	1.11	1.11	1.11
HE80	-	0.96	0.99	1.00	1.03	1.04	1.03	1.03
HE90	-	0.91	0.96	1.00	1.04	1.11	N/A	N/A
HD95	-	0.91	0.96	1.00	1.04	1.11	1.03	1.04
SUN95	-	0.90	0.92	1.00	1.01	1.07	1.04	1.05
HCD	-	N/A	0.96	1.00	1.04	1.04	1.04	1.04
HCN	-	0.87	0.96	1.00	1.04	N/A	N/A	N/A

BIOS TECHNOLOGY

Choosing Your BIOS Solution

BIOS is offered in four Circadian LED Solutions with BIOS SkyBlue Technology — Biological Static, Biological Dynamic, Biological Tunable, and Biological Dim-to-Warm. BIOS SkyBlue™ Technology includes a blue peak at 490nm that provides an effective daytime circadian signal using standard architectural color temperatures.



To learn more about BIOS Technology, please click or scan the QR Code.



BIOS Static

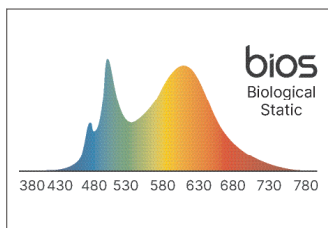

BIOS Dynamic

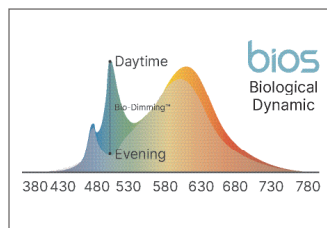

BIOS Tunable

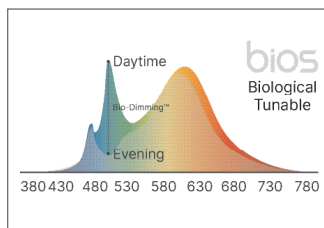

BIOS Dim-to-Warm

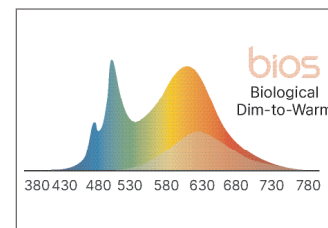

Daytime

No color change when dimmed

Spaces that operate during daytime hours — 7am and 7pm

Daytime & Evening

500K shift when dimmed

Spaces that operate overnight — after 7pm and before 7am

Daytime & Evening

Dims to 2700K

Spaces that operate with overnight shifts — after 7pm and before 7am

Daytime & Evening

Dims from cool to warm

Spaces where people sleep — after 7pm and before 7am

Circadian and Human Centric Light

CODE	DESCRIPTION	BIO-DIMMING MODULE TECHNOLOGY GUIDE					
		Driver	Driver Voltage	CCT	Requires BIO-Dimming Module	Lighting Control	BIOS SkyBlue (490nm)
SBIOS	BIOS Static	DIM1	0-10V Dimming to 1% Dim-to-Dark	No CCT Change	No	Intensity Dimming Control Only	Always Present
DBIOS	BIOS Dynamic	BIODIM1	0-10V Intensity Dimming to 1% Dim-to-Dark	500K Shift	Yes	Intensity Dimming & Spectrum Change Controlled Together	Removed with BIO-Dimming
DBIOS-2	BIOS Dynamic (Two Channel)				No	Intensity Dimming & Spectrum Change Controlled Separately	Removed by Adjusting "Spectrum Channel"
TBIOS	BIOS Tunable	ATW / DTW	0-10V Control of Intensity & CCT on Separate 2 Channels / DALI Control of Intensity & CCT on Separate 2 Channels	Dims to 2700K	Yes	Intensity Dimming & Spectrum Change Controlled Together	Removed with BIO-Dimming
TBIOS-2	BIOS Tunable (Two Channel)				No	Intensity Dimming & Spectrum Change Controlled Separately	Removed by Adjusting "Spectrum Channel"
DWBIOS	BIOS Dim-to-Warm	-	-	Dims to 2200K	Yes	Intensity Dimming & Spectrum Change Controlled Together	Removed with BIO-Dimming
DWBIOS-2	BIOS Dim-to-Warm (Two Channel)				No	Intensity Dimming & Spectrum Change Controlled Separately	Removed by Adjusting "Spectrum Channel"

SMARTBEAM® TECHNOLOGY

The Ultimate Control of Lighting Distributions

SmartBeam makes it easy to specify the exact light required for any architectural space. Available in every XICO product; it is now possible to create truly tailored and engaging lighting that transform spaces, improves visual comfort, and saves energy.

To learn more about our SmartBeam Technology, please click or scan the QR Code.



FIXTURE POWER & CONTROLS

Voltage

LED Driver Factory Selected, 36–39V Constant Current

Emergency Backup

Backup Types Emergency Circuit, Emergency Battery (Remote), and other emergency backups are available

Wiring Typically the Emergency Backup is wired to 48” sections

Power 10 W

Illumination Time 90 minutes

Partners



Control Systems

Other Remote Drivers (Sold Separately)
 Factory Non-Dimming, Factory 0–10V 1% Dim, Factory 0–10V 10% Dim, Factory DALI 0.1% Dim, Factory DMX Dim, Factory TRIAC Dim, eldoLED 0–10V 0.1% Dim, eldoLED 0–10V 1% Dim, eldoLED DALI 0.1% Dim, and other drivers are available, consult factory (not all integral)

Lutron Hi-Lume 1% Dimming and 5-Series 5% Dimming

Cooper Compatible driver

Casambi (wireless) Compatible driver

XBox

Remote Driver Boxes (Optional) To create a clean and organized power solution for multiple fixture installations see our Xbox Specification Guide. Reach out to a XICO Sales Representative to discuss your projects needs.



Flush Lens

FIXTURE MOUNTING & CONNECTIONS

Mounting Type

T-Bar Mount

Installs into a ceiling grid system and mount on to, or replace, typical T-Bar elements. Available with a range of accessories, mounts and inserts that provide easy customization of visual appearance and performance enhancements.

Surface Mount

Installs onto a surface via a junction box or magnet. Available with a range of accessories, mounts and inserts that provide easy customization of visual appearance and performance enhancements.

Power Cords

24" Cable Kit

White and Black

Mounting Kit

Surface Mounting Bracket

Stainless Steel

Mounting Options

DJ - Drywall/J-Box Mount

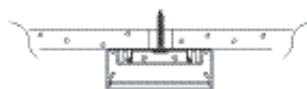

M1 - Magnet Mount



T1 - 9/16" Flat T-Bar Mount

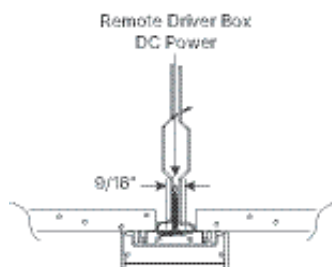

T2 - 9/16" Bolt Slot T-Bar Mount

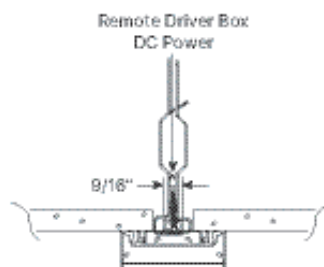

T3 - 15/16" Flat T-Bar Mount

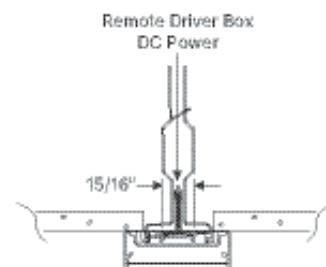

Standard Lengths & Continuous Runs

Maximum length of one fixture is 10'. Longer runs can be produced by joining sections. Customer approval of shop drawings is required prior to build of any non-standard length order.

Single Fixture



Standard Continuous Run

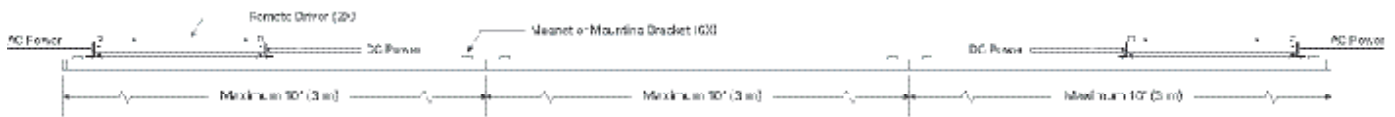

Emergency Battery Backup

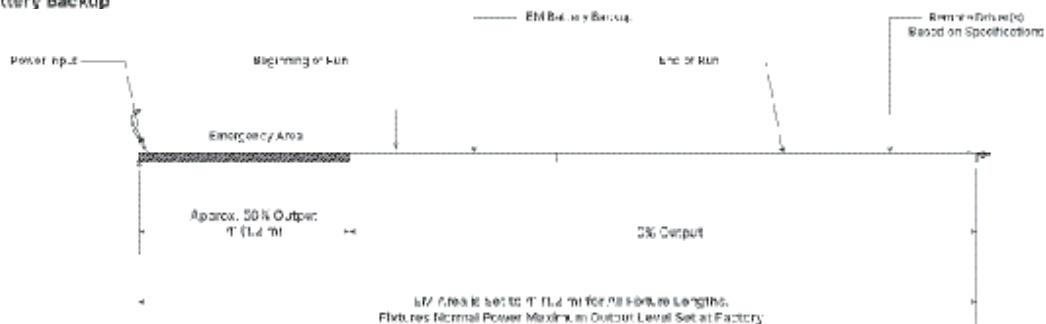

EM Area is set to 1' (1.4 m) for all fixture lengths. Fixtures Normal Power Maximum Output Level Set at Factory

Battery Power 10 W
 Illumination Time: 90 minutes
 Light Output approx 500 lux/ft or 1500-1500 Total Lux/area*
 Recharge Time: 24 Hours

*Light output may vary based on fixture output level and ambient conditions

PATENTS & TRADEMARKS



To learn more about our unique technologies, please click or scan the QR Code.

Utility Patents

United States	US11543582, US11520097, US11512466, US11441749, US11396751, US11333822, US11163104, US11156762, US10852466, US10068447, US8953926, US8948564, US8911099, US8876348, US8794812, US8783898, US8761565, US8750671, US8721152, US8619363, US8430548, US8408775, US8249408, US8231256, US8177408, US8033706, US8033674, US7991257, US7914192, US7784954, US7758227, US7722224, US7542635, US7453636, US7453635, US7431489, US7408707, US7278775, US6369944, US6346311, US6123877, US5932342, US5837346, US20220373144, US20220372752, US20220364708, US20220357006, US20220357005, US20220342141, US20220290432, US20220206210A1, US20220171119A1, US20220171115A1, US20220162856A1, US20220162853A1, US20220146063A1, US20220137287, US20210301991A1, US20200355345A1, US20200217071A1, US20220333765A1, US20220228366A1, US20220196906A1, US20220010554A1, US20080043490A1, US20060290253A1, US20060215958A1, US20120321247, US20120250330, US20120099204
Canada	CA2702600, CA2702685, CA2702690
France	FREP0800658
Germany	DEEP0800658
Great Britain	GB2492541, GB2492542, GBEP0800658, GB2492398
Japan	JP03958359
Netherlands	NLEP0800658
Taiwan	FTW360813B
European Patent Organization	EP0843203, EP0843203

Design Patents

United States	USD719282, USD717973, USD669606, USD669608, USD669609, USD669614, USD663056
----------------------	---

The Patent Corporation Treaty

World Intellectual Property Organization	WO2015200268
---	--------------

Trademarks

United States	US6672871, US6397231, US6373493, US6257728, US6190558, US6190559, US6142905, US6114408, US6038234, US6025279, US6060740, US6257729, US5856164, US5734112, US5543304, US5309290, US5309315, US4691124, US4640751
----------------------	---