

## EDGESolo275 Pendant 2.75" Edge-Lit Linear LED Pendant Mount

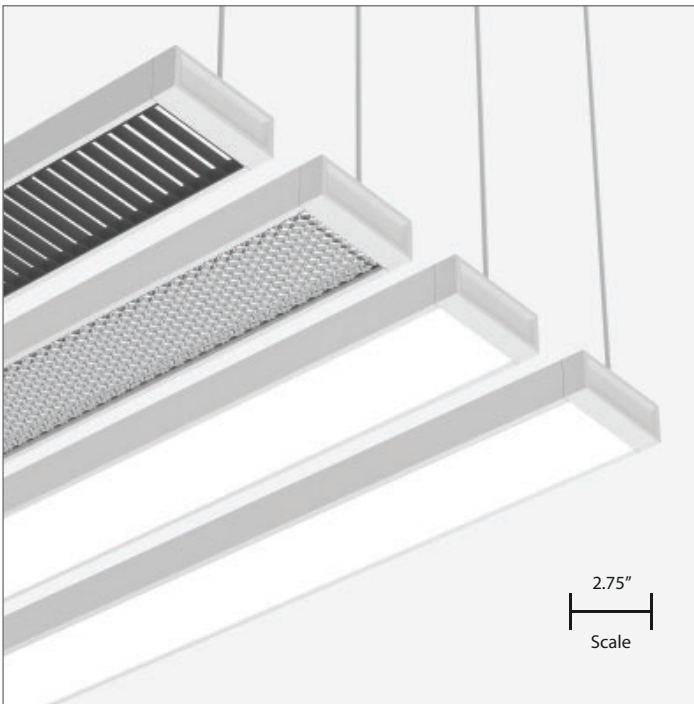

### Features & Benefits

Exceptional Performance  
Up to 1,000 lm/ft, 135 lm/W efficacy

Wide Range of LED Selections  
Static and Tunable White

Designed with Options  
Wide choice of SmartOptic® lenses, beam distributions, 80/90/95+ CRI, 2200K to 5000K CCT, and 0-10V, DALI, DMX, and TRIAC dimming

Patented Innovations  
Fusion® Optix Inside with unique SmartBeam® capabilities

Proprietary Optical Components  
Provides excellent light distribution and high-transmission

Committed to Sustainability  
Declare Listed and Red Free List materials

Compliance  
UL Listed, Dry and Damp Locations

5-Year Warranty  
Standard 5-year warranty, 50,000 hours



Designed & Built in  
**BOSTON**



### FIXTURE ORDERING

Project Name

Fixture Type

#### 1) FIXTURE DESIGN

PRODUCT	LENGTH	FINISH	END CAP	OPTIC (DIRECT ONLY)
<b>ESO275-P</b>				
2.75" Edge-Lit Linear LED Pendant Mount	2FT 2ft Nominal 4FT 4ft Nominal 6FT 6ft Nominal 8FT 8ft Nominal 10FT 10ft Nominal X_ Specify X; Y"	<b>Powder Coated Colors</b> PMW Matte White (RAL9003) PMB Matte Black (RAL9005) PMG Matte Gray (RAL7001) PCAE Clear Anodized Effect PRAL_ Specify RAL#	E1 Flat End Cap E2 Chamfered End Cap	OFL Flush Lens RFL Regressed Flush Lens RFL-WLB RFL + White Linear Baffle RFL-BLB RFL + Black Linear Baffle RFL-WHB RFL + White Hexagonal Baffle RFL-BHB RFL + Black Hexagonal Baffle

#### 2) LED LIGHT ENGINE

CRI	CCT	DIRECT BEAM PATTERN	DIRECT OUTPUT	INDIRECT BEAM PATTERN	INDIRECT OUTPUT
S80 Std. 80 CRI S90 Std. 90 CRI HE80 High-Eff. 80 CRI HE90 High-Eff. 90 CRI HD95 High-Def. 95 CRI SUN Full SunLike	22 2200K 27 2700K 30 3000K 35 3500K 40 4000K 50 5000K X_ Specify CCT	DLAM Lambertian DBW65 Batwing 65° DA5025 Asymmetric 50° at 25° Tilt X_ Specify Beam	35 350 lm/ft 50 500 lm/ft 75 750 lm/ft 100 1,000 lm/ft X_ Specify lm/ft	NN Not Needed ILAM Lambertian IBW120 Batwing 120° IFT150 FlatTop 150° IA6040 Asymmetric 60° at 40° Tilt IA4560 Asymmetric 45° at 60° Tilt X_ Specify Beam	NN Not Needed 35 350 lm/ft 50 500 lm/ft 75 750 lm/ft 100 1,000 lm/ft X_ Specify lm/ft

#### 3) FIXTURE POWER & CONTROLS

LINE VOLTAGE (DC)	REMOTE DRIVER (POWER)	REMOTE DRIVER BOX <sup>1</sup>	EMERGENCY BACKUP	CONTROL SYSTEM <sup>3</sup>
UNV 120/277V 347 347V	FDND Factory Non-Dimming FD01 Factory 0-10V 1% Dim FD10 Factory 0-10V 10% Dim FDDA Factory DALI 0.1% Dim FDDX Factory DMX Dim FDTR Factory TRIAC Dim LD01 Lutron Hi-Lume 1% Dim LD05 Lutron 5-Series 5% Dim ED00 eldoLED 0-10V 0.1% Dim ED01 eldoLED 0-10V 1% Dim EDDA eldoLED DALI 0.1% Dim X_ Specify Driver	NN Not Needed RLDB <sup>2</sup> Remote Linear Driver Box (driver included by default) RX2D <sup>2</sup> Optional Remote XBox2 Driver, Up to 2 Drivers RX3D <sup>2</sup> Optional Remote XBox3 Driver, Up to 3 Drivers RX5D <sup>2</sup> Optional Remote XBox5 Driver, Up to 5 Drivers	NN Not Needed EMC Emergency Circuit EMB Emergency Battery (10 W — Remote) X_ Specify Backup	NN Not Needed LUT Lutron COO Cooper CAS Casambi X_ Specify Control System

#### 4) FIXTURE MOUNTING & CONNECTIONS

MOUNTING TYPE	CANOPY	POWER CORD
DJ Drywall/J-Box Mount T1 9/16" Flat T-Bar Mount T2 9/16" Bolt Slot T-Bar Mount T3 15/16" Flat T-Bar Mount	RCWH2 2" Round Canopy, White RCBK2 2" Round Canopy, Black RCWH5 5" Round Canopy, White RCBK5 5" Round Canopy, Black	SQCWH2 2" Square Canopy, White SQCBK2 2" Square Canopy, Black SQCWH5 5" Square Canopy, White SQCBK5 5" Square Canopy, Black

Footnotes: <sup>1</sup> Remote distance is dependent on driver type, up to 100' (30.5 m). <sup>2</sup> Creates a clean and organized power solution for multiple fixture installations.

<sup>3</sup> The control system and driver must be compatible.

Project Name

Fixture Type

NOTES

### REMOTE DRIVER BOX

Dimensions

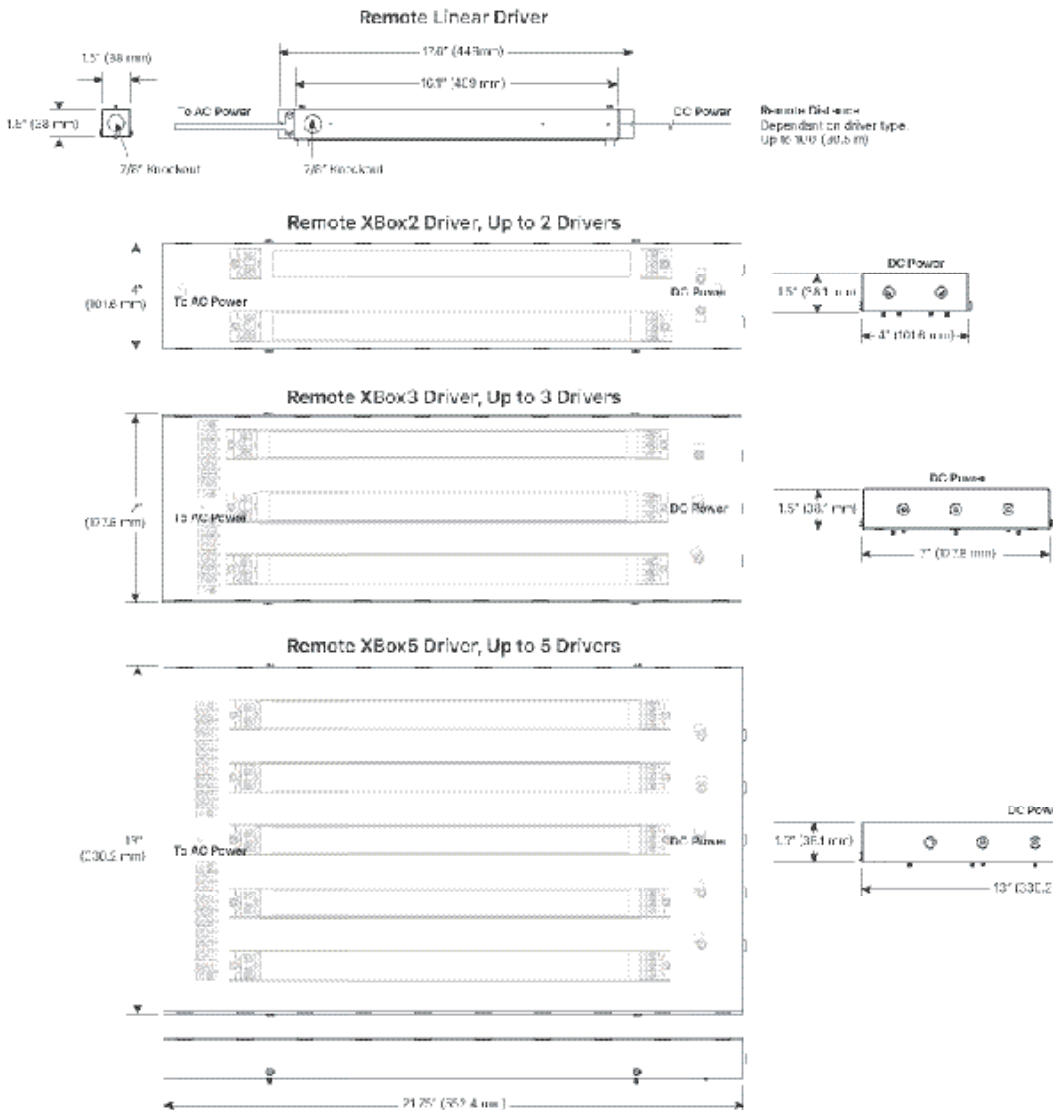

## FIXTURE DESIGN

### Dimensions

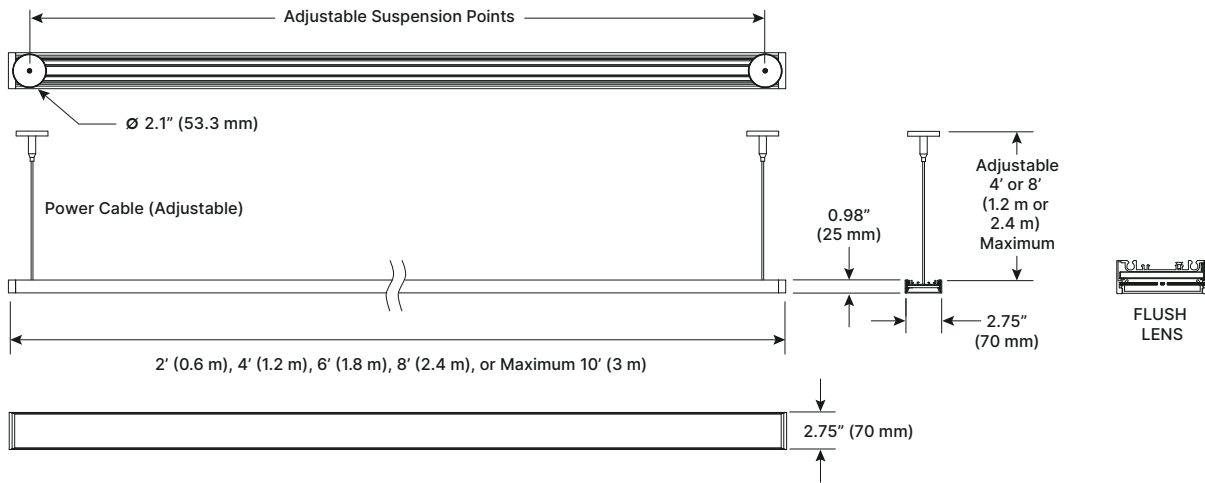

To download BIM (Revit) Files, please click or scan the QR Code.

### Length

Length Options 2', 4', 6', 8', 10' nominal, or custom within 3"

### Finish

#### Housing Colors (Matte Finish)



White (RAL9003)



Black (RAL9005)



Gray (RAL7001)



Clear Anodized Effect



Custom RAL

Housing Material 6063-T5 extruded, recycled aluminum

Mounting Brackets Sheet metal

### End Cap

End Cap Option Chamfered

End Cap Material Machined or cast aluminum

### Optic

Lens Option Flush

Lens Material Patented SmartOptics® made from Acrylic (PMMA)

### Voltage

Fixture Voltage (AC) 120–277 VAC and 347 VAC, 50/60 Hz

## LED SELECTION GUIDE

S80: Standard 80+ CRI

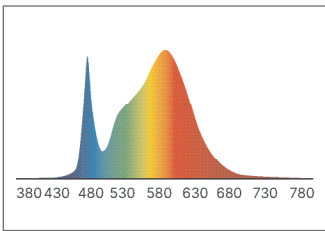

S90: Standard 90+ CRI

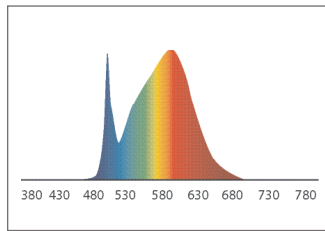

HE80: High-Efficiency 80+ CRI

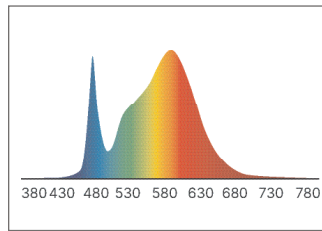

HE90: High-Efficiency 90+ CRI

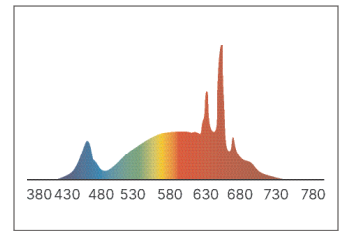

HD95: High-Definition 95+ CRI

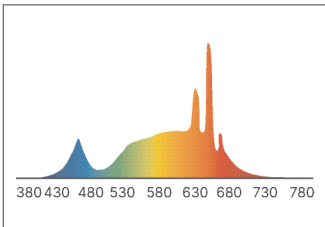

SUN: Full Spectrum "SunLike"

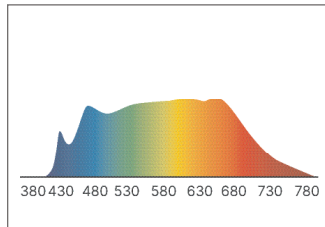

HCD: Human Centric Day

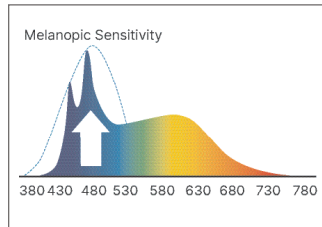

HCN: Human Centric Night

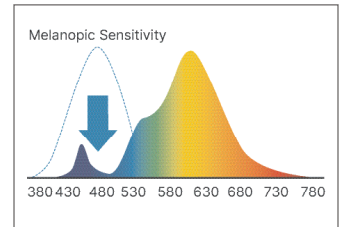

### Static White Light (LED Light Engine Only)

CODE	DESCRIPTION	TYPICAL LED DATA							
		CCT	CRI	CRI R9	TM30 Rf	TM30 Rg	CQS	M/P Ratio	LPW
S80	Standard 80 CRI	3500K	82.5	7.8	84	96.7	82.5	0.51	190
S90	Standard 90 CRI	3500K	91	54.3	89.3	98.9	89.2	0.55	175
HE80	High Efficiency 80 CRI	3500K	82.1	5.9	83	94.2	81.2	0.52	210
HE90	High Efficiency 90 CRI	3500K	92.2	90	90.7	103.8	92.1	0.56	190
HD95	High Definition 95 CRI	3500K	97.1	95	-	-	-	0.70	163
SUN	Full Spectrum SunLike®	3500K	95	85	-	-	-	-	130
HCD	Human Centric Day	4000K	83	95	-	-	-	0.92	155
HCN	Human Centric Night	2700K	80	-	-	-	-	0.44	134

### LPW Efficacy Conversion Chart

CODE	CCT SELECTED							
	2200K	2700K	3000K	3500K	4000K	5000K	5700K	6500K
S80	-	0.91	0.96	1.00	1.04	1.11	1.11	1.11
S90	-	0.91	0.96	1.00	1.04	1.11	1.11	1.11
HE80	-	0.96	0.99	1.00	1.03	1.04	1.03	1.03
HE90	-	0.91	0.96	1.00	1.04	1.11	N/A	N/A
HD95	-	0.91	0.96	1.00	1.04	1.11	1.03	1.04
SUN95	-	0.90	0.92	1.00	1.01	1.07	1.04	1.05
HCD	-	N/A	0.96	1.00	1.04	1.04	1.04	1.04
HCN	-	0.87	0.96	1.00	1.04	N/A	N/A	N/A

## BIOS TECHNOLOGY

### Choosing Your BIOS Solution

BIOS is offered in four Circadian LED Solutions with BIOS SkyBlue Technology — Biological Static, Biological Dynamic, Biological Tunable, and Biological Dim-to-Warm. BIOS SkyBlue™ Technology includes a blue peak at 490nm that provides an effective daytime circadian signal using standard architectural color temperatures.



To learn more about BIOS Technology, please click or scan the QR Code.



BIOS Static

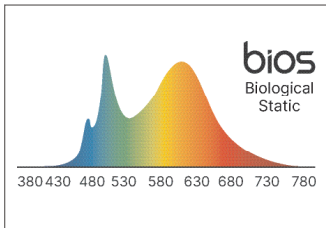

BIOS Dynamic

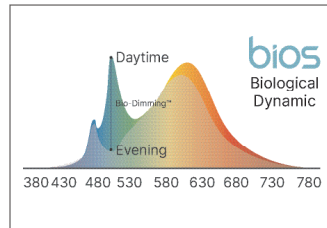

BIOS Tunable

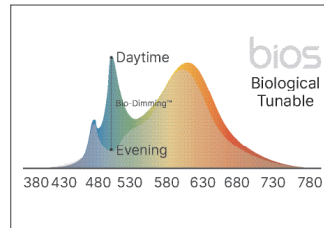

BIOS Dim-to-Warm

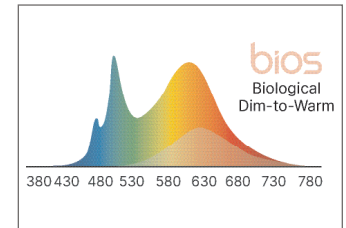

#### Daytime

No color change when dimmed

Spaces that operate during daytime hours — 7am and 7pm

#### Daytime & Evening

500K shift when dimmed

Spaces that operate overnight — after 7pm and before 7am

#### Daytime & Evening

Dims to 2700K

Spaces that operate with overnight shifts — after 7pm and before 7am

#### Daytime & Evening

Dims from cool to warm

Spaces where people sleep — after 7pm and before 7am

### Circadian and Human Centric Light

CODE	DESCRIPTION	BIO-DIMMING MODULE TECHNOLOGY GUIDE					
		Driver	Driver Voltage	CCT	Requires BIO-Dimming Module	Lighting Control	BIOS SkyBlue (490nm)
SBIOS	BIOS Static	DIM1	0-10V Dimming to 1% Dim-to-Dark	No CCT Change	No	Intensity Dimming Control Only	Always Present
DBIOS	BIOS Dynamic	BIODIM1	0-10V Intensity Dimming to 1% Dim-to-Dark	500K Shift	Yes	Intensity Dimming & Spectrum Change Controlled Together	Removed with BIO-Dimming
DBIOS-2	BIOS Dynamic (Two Channel)				No	Intensity Dimming & Spectrum Change Controlled Separately	Removed by Adjusting "Spectrum Channel"
TBIOS	BIOS Tunable	ATW / DTW	0-10V Control of Intensity & CCT on Separate 2 Channels / DALI Control of Intensity & CCT on Separate 2 Channels	Dims to 2700K	Yes	Intensity Dimming & Spectrum Change Controlled Together	Removed with BIO-Dimming
TBIOS-2	BIOS Tunable (Two Channel)				No	Intensity Dimming & Spectrum Change Controlled Separately	Removed by Adjusting "Spectrum Channel"
DWBIOS	BIOS Dim-to-Warm	-	-	Dims to 2200K	Yes	Intensity Dimming & Spectrum Change Controlled Together	Removed with BIO-Dimming
DWBIOS-2	BIOS Dim-to-Warm (Two Channel)				No	Intensity Dimming & Spectrum Change Controlled Separately	Removed by Adjusting "Spectrum Channel"

## SMARTBEAM® TECHNOLOGY

The Ultimate Control of Lighting Distributions

SmartBeam makes it easy to specify the exact light required for any architectural space. Available in every XICO product; it is now possible to create truly tailored and engaging lighting that transform spaces, improves visual comfort, and saves energy.

To learn more about our SmartBeam Technology, please click or scan the QR Code.



## FIXTURE POWER & CONTROLS

### Voltage

LED Driver                      Factory Selected, 36–39V Constant Current

### Emergency Backup

Backup Types                      Emergency Circuit, Emergency Battery (Remote), and other emergency backups are available

Wiring                              Typically the Emergency Backup is wired to 48" sections

Power                                10 W

Illumination Time                90 minutes

### Partners



### Control Systems

Remote Drivers (Sold Separately)

Other                                Factory Non-Dimming, Factory 0–10V 1% Dim, Factory 0–10V 10% Dim, Factory DALI 0.1% Dim, Factory DMX Dim, Factory TRIAC Dim, eldoLED 0–10V 0.1% Dim, eldoLED 0–10V 1% Dim, eldoLED DALI 0.1% Dim, and other drivers are available, consult factory (not all integral)

Lutron                                Hi-Lume 1% Dimming and 5-Series 5% Dimming

Cooper                                Compatible driver

Casambi (wireless)                Compatible driver

### XBox

Remote Driver Boxes (Optional)                To create a clean and organized power solution for multiple fixture installations see our Xbox Specification Guide. Reach out to a XICO Sales Representative to discuss your projects needs.



Flush Lens

## FIXTURE MOUNTING & CONNECTIONS

### Mounting Type

#### T-Bar Mount

Installs into a ceiling grid system and mount on to, or replace, typical T-Bar elements. Available with a range of accessories, mounts and inserts that provide easy customization of visual appearance and performance enhancements.

#### Drywall/J-Box Mount

Installs onto a surface via a junction box. Available with a range of accessories, mounts and inserts that provide easy customization of visual appearance and performance enhancements.

### Canopy

#### Canopy Sizes & Shapes

2" and 5", Round and Square

#### Canopy Colors



White (RAL9003)

Black (RAL9005)

#### Canopy Material

Powder Coated Steel

### Power Cords

#### 48" Cable Kit

White and Black

#### 96" Cable Kit

White and Black

### Mounting Options

Typically suspended at a distance of between 24" and 72". Supplied hardware includes:

- Cable length adjustable at fixture level
- Standard 96" cord length or custom length
- Internal brackets to eliminate light leakage at joints

#### DJ - Drywall/J-Box Mount

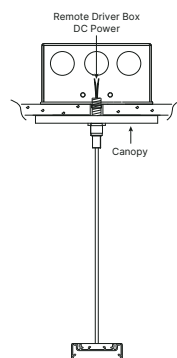

#### T1 - 9/16" Flat T-Bar Mount

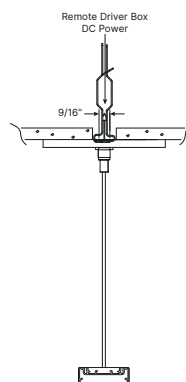

#### T2 - 9/16" Bolt Slot T-Bar Mount

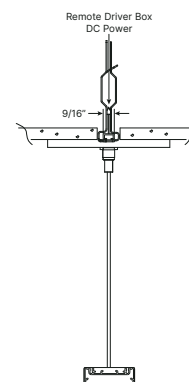

#### T3 - 15/16" Flat T-Bar Mount

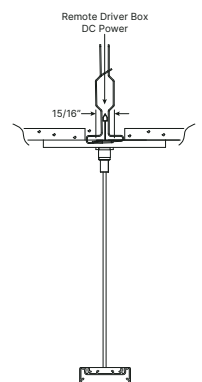



## Standard Lengths & Continuous Runs

Maximum length of one fixture is 10'. Longer runs can be produced by joining sections. Customer approval of shop drawings is required prior to build of any non-standard length order.

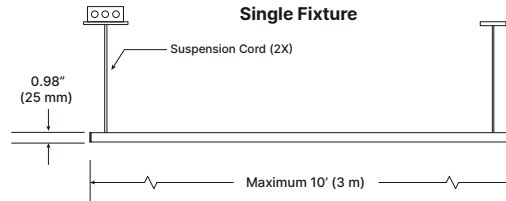

### Standard Continuous Run

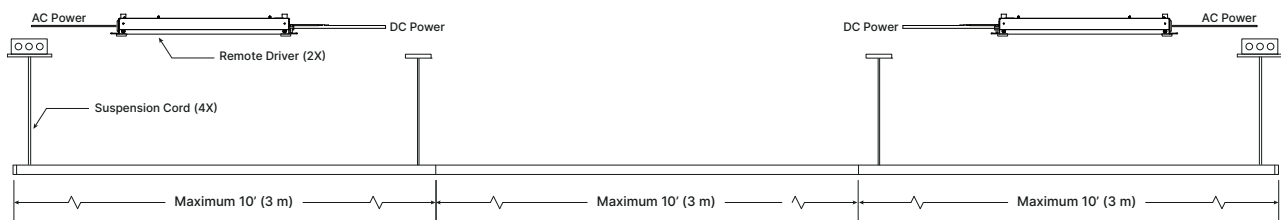

### Emergency Battery Backup

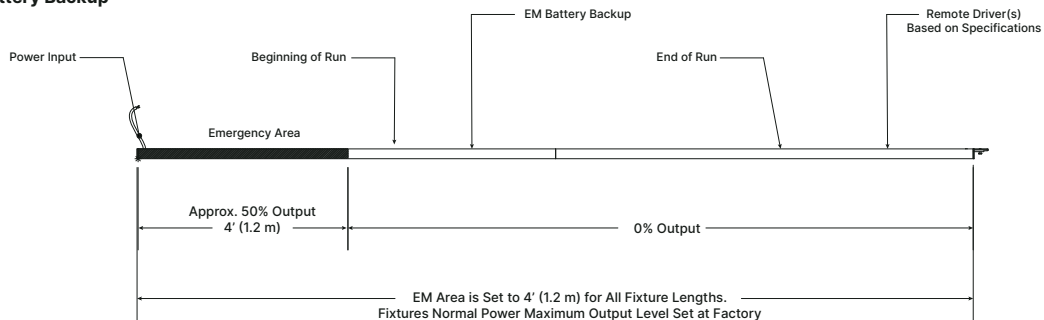

Battery Power: 10 W  
 Illumination Time: 90 minutes  
 Light Output approx 300 lm/ft or 1200-1300 Total Lumens\*  
 Recharge Time: 24 Hours

\*Light output may vary based on fixture output level ordered.

## STANDARDS & CERTIFICATIONS

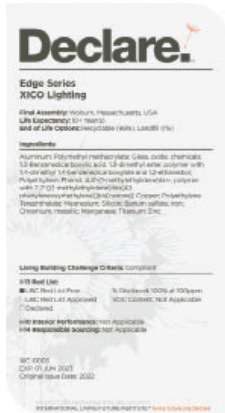

### Declare Listed

Declare labels provide a quick and reliable way to make choices about the environmental footprint and safety of the product. Declare is internationally recognized and the labels can be found on the product, product packaging, or company website. Visit [xicoled.com](http://xicoled.com) for Declare Listed details.



### Red List Free

An industry standard certification for LED lighting products based on the International Living Future Institute (ILFI). These products only use materials based on the “Red List of Toxic Chemicals” (a list of chemicals and materials known to be hazardous to people and/or the Earth) that are safe, healthy, and environmentally sustainable.

## Certifications

Compliance

BAA & TAA compliant in-house manufacturing in Boston, MA with North American supply chain

Certifications



Sustainability

Declare Listed and Red List Free

Packaging

Low carbon, environmentally conscious packaging and shipping methods

## Environmental Suitability

IP Rating

Suitable for Dry and Damp Locations, indoor use only

Recyclable

SmartOptics and all powder coated and anodized parts are fully recyclable at end of life

## Reliability

Manufacturing

All XICO products and associated optics and LED engines are assembled at our factory in Woburn, MA

Quality Assurance

Each product is engineered reliability and quality assurance tested

## Warranty & Terms

5-YR Warranty

Business Terms



For details on our warranty and business terms, please click or scan the QR Code.

OPTIC	BEAM PATTERN		
	DLAM	DBW65	DA5025
Flush Lens	●	●	●

### DIRECT PHOTOMETRICS

Static White Light

DLAM: Lambertian

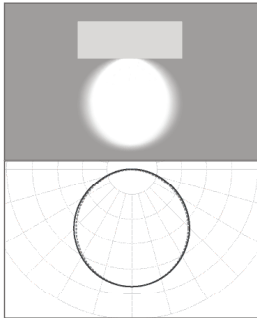

Length 48"  
LED HE80  
CRI/CCT 80+/3500K  
Lumens 3,000  
lm/ft 746  
Watts 27  
W/ft 6.8  
LPW 110

DBW65: Batwing 65°

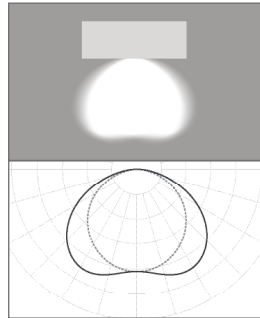

Length 48"  
LED HE80  
CRI/CCT 80+/3500K  
Lumens 3,000  
lm/ft 743  
Watts 27  
W/ft 6.8  
LPW 109

DA5025: Asymmetric 50° at 25° Tilt

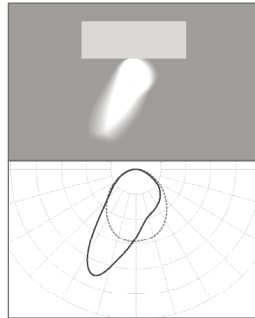

Length 48"  
LED HE80  
CRI/CCT 80+/3500K  
Lumens 3,000  
lm/ft 738  
Watts 10.5  
W/ft 5.3  
LPW 141

### INDIRECT PHOTOMETRICS

Static White Light

ILAM: Lambertian

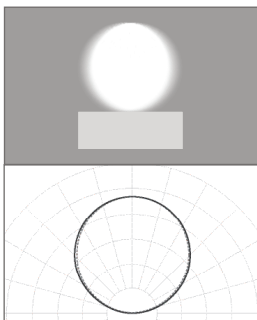

Length 48"  
LED HE80  
CRI/CCT 80+/3500K  
Lumens 4,000  
lm/ft 1,000  
Watts 28  
W/ft 7  
LPW 150

IBW120: Batwing 120°

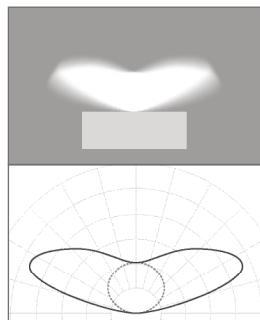

Length 48"  
LED HE80  
CRI/CCT 80+/3500K  
Lumens 4,000  
lm/ft 1,017  
Watts 25  
W/ft 6.3  
LPW 162

IFT150: FlatTop 150°

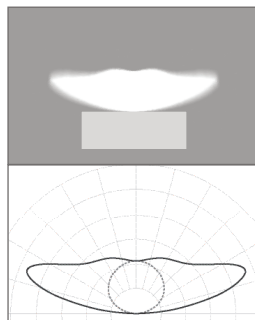

Length 48"  
LED HE80  
CRI/CCT 80+/3500K  
Lumens 4,000  
lm/ft 1,004  
Watts 26  
W/ft 6.5  
LPW 155

IA6040: Asymmetric 60° at 40° Tilt

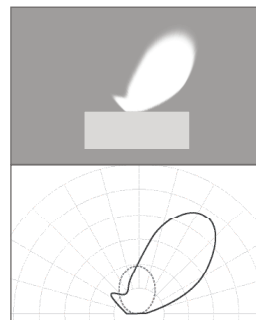

Length 48"  
LED HE80  
CRI/CCT 80+/3500K  
Lumens 4,000  
lm/ft 991  
Watts 28  
W/ft 7  
LPW 143

IA4560: Asymmetric 45° at 60° Tilt

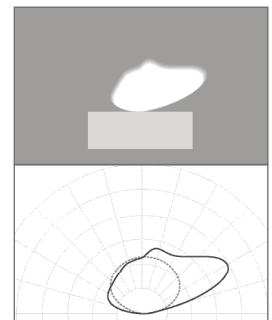

Length 48"  
LED HE80  
CRI/CCT 80+/3500K  
Lumens 4,000  
lm/ft 991  
Watts 28  
W/ft 7  
LPW 143

## PATENTS & TRADEMARKS



To learn more about our unique technologies, please click or scan the QR Code.

### Utility Patents

United States	US11543582, US11520097, US11512466, US11441749, US11396751, US11333822, US11163104, US11156762, US10852466, US10068447, US8953926, US8948564, US8911099, US8876348, US8794812, US8783898, US8761565, US8750671, US8721152, US8619363, US8430548, US8408775, US8249408, US8231256, US8177408, US8033706, US8033674, US7991257, US7914192, US7784954, US7758227, US7722224, US7542635, US7453636, US7453635, US7431489, US7408707, US7278775, US6369944, US6346311, US6123877, US5932342, US5837346, US20220373144, US20220372752, US20220364708, US20220357006, US20220357005, US20220342141, US20220290432, US20220206210A1, US20220171119A1, US20220171115A1, US20220162856A1, US20220162853A1, US20220146063A1, US20220137287, US20210301991A1, US20200355345A1, US20200217071A1, US20220333765A1, US20220228366A1, US20220196906A1, US20220010554A1, US20080043490A1, US20060290253A1, US20060215958A1, US20120321247, US20120250330, US20120099204
Canada	CA2702600, CA2702685, CA2702690
France	FREP0800658
Germany	DEEP0800658
Great Britain	GB2492541, GB2492542, GBEP0800658, GB2492398
Japan	JP03958359
Netherlands	NLEP0800658
Taiwan	FTW360813B
European Patent Organization	EP0843203, EP0843203

### Design Patents

United States	USD719282, USD717973, USD669606, USD669608, USD669609, USD669614, USD663056
---------------	---

### The Patent Corporation Treaty

World Intellectual Property Organization	WO2015200268
--	--------------

### Trademarks

United States	US6672871, US6397231, US6373493, US6257728, US6190558, US6190559, US6142905, US6114408, US6038234, US6025279, US6060740, US6257729, US5856164, US5734112, US5543304, US5309290, US5309315, US4691124, US4640751
---------------	---